



2Mx32 5V FLASH MODULE, SMD 5962-97531 (pending) PRELIMINARY*

FEATURES

- Access Time of 90, 120, 150ns
- Packaging:
 - 66 pin, PGA Type, 1.185" square, Hermetic Ceramic HIP (Package 401).
 - 68 lead, Hermetic COFP (G2U), 22.4mm (0.880") square (Package 510) 3.56mm (0.140") height. Designed to fit JEDEC 68 lead 0.990" COFJ footprint (Fig. 3)
- Sector Architecture
 - 32 equal size sectors of 64KBytes per each 2Mx8 chip
 - Any combination of sectors can be erased. Also supports full chip erase.
- Minimum 100,000 Write/Erase Cycles Minimum
- Organized as 2Mx32
- Commercial, Industrial, and Military Temperature Ranges
- 5 Volt Read and Write. 5V ± 10% Supply.
- Low Power CMOS
- Data Polling and Toggle Bit feature for detection of program or erase cycle completion.
- Supports reading or programming data to a sector not being erased.
- RESET pin resets internal state machine to the read mode.
- Built in Decoupling Caps and Multiple Ground Pins for Low Noise Operation, Separate Power and Ground Planes to improve noise immunity

* This data sheet describes a product under development, not fully characterized, and is subject to change without notice.

Note: For programming information refer to Flash Programming 16M5 Application Note.

FIG. 1 PIN CONFIGURATION FOR WF2M32-XXH5

TOP VIEW

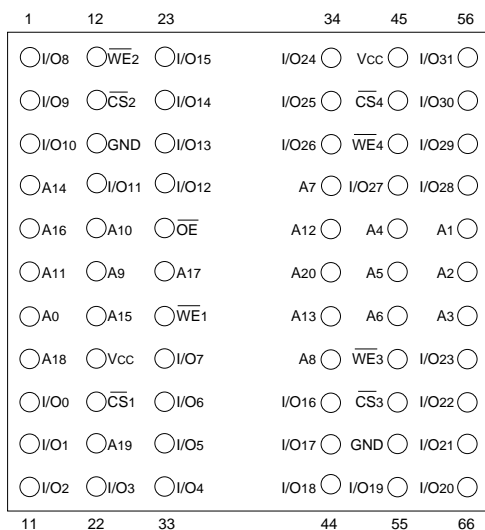

PIN DESCRIPTION

I/O0-31	Data Inputs/Outputs
A0-20	Address Inputs
WE1-4	Write Enables
CS1-4	Chip Selects
OE	Output Enable
Vcc	Power Supply
GND	Ground

BLOCK DIAGRAM

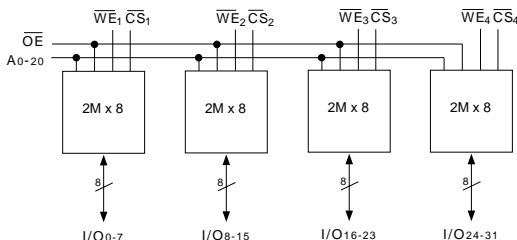

RESET internally tied to Vcc in the HIP package for this pin configuration. See Alternate Pin Configuration with RESET tied to pin 12 for system control of reset (Fig. 10, page 11)



FIG. 2 PIN CONFIGURATION FOR WF2M32-XG2UX5

TOP VIEW

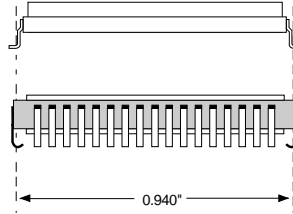
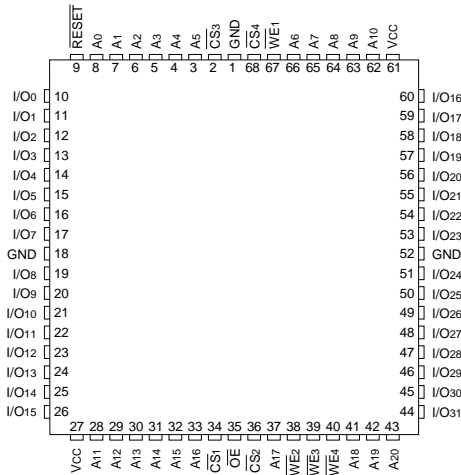

The White 68 lead G2U COFP fills the same fit and function as the JEDEC 68 lead COFJ or 68 PLCC. But the G2U has the TCE and lead inspection advantage of the COFP form.

PIN DESCRIPTION

Pin	Description
I/O0-31	Data Inputs/Outputs
A0-20	Address Inputs
WE1-4	Write Enables
CS1-4	Chip Selects
OE	Output Enable
Vcc	Power Supply
GND	Ground
RESET	Reset

BLOCK DIAGRAM

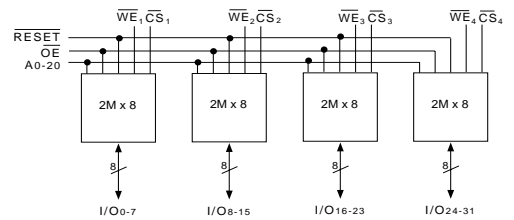



ABSOLUTE MAXIMUM RATINGS

Parameter	Symbol	Ratings	Unit
Voltage on Any Pin Relative to V _{SS}	V _T	-2.0 to +7.0	V
Power Dissipation	P _T	8	W
Storage Temperature	T _{stg}	-65 to +125	°C
Short Circuit Output Current	I _{os}	100	mA
Endurance - Write/Erase Cycles (Mil Temp)		100,000 min	cycles
Data Retention (Mil Temp)		20	years

RECOMMENDED DC OPERATING CONDITIONS

Parameter	Symbol	Min	Typ	Max	Unit
Supply Voltage	V _{CC}	4.5	5.0	5.5	V
Ground	V _{SS}	0	0	0	V
Input High Voltage	V _{IH}	2.0	-	V _{CC} + 0.5	V
Input Low Voltage	V _{IL}	-0.5	-	+0.8	V
Operating Temperature (Mil.)	T _A	-55	-	+125	°C
Operating Temperature (Ind.)	T _A	-40	-	+85	°C

DC CHARACTERISTICS - CMOS COMPATIBLE

(V_{CC} = 5.0V, V_{SS} = 0V, T_A = -55°C to +125°C)

Parameter	Symbol	Conditions	Min	Max	Unit
Input Leakage Current	I _{LI}	V _{CC} = 5.5, V _{IN} = GND to V _{CC}		10	μA
Output Leakage Current	I _{LOx32}	V _{CC} = 5.5, V _{IN} = GND to V _{CC}		10	μA
V _{CC} Active Current for Read (1)	I _{CC1}	$\overline{CS} = V_{IL}, \overline{OE} = V_{IH}, f = 5\text{MHz}$		160	mA
V _{CC} Active Current for Program or Erase (2)	I _{CC2}	$\overline{CS} = V_{IL}, \overline{OE} = V_{IH}$		240	mA
V _{CC} Standby Current	I _{CC3}	V _{CC} = 5.5, $\overline{CS} = V_{IH}, f = 5\text{MHz}, \overline{RESET} = V_{CC} \pm 0.3\text{V}$		8.0	mA
Output Low Voltage	V _{OL}	I _{OL} = 12.0 mA, V _{CC} = 4.5		0.45	V
Output High Voltage	V _{OH}	I _{OH} = -2.5 mA, V _{CC} = 4.5	0.85xV _{CC}		V
Low V _{CC} Lock-Out Voltage	V _{LKO}		3.2	4.2	V

NOTES:

- The I_{CC} current listed includes both the DC operating current and the frequency dependent component (@ 5MHz). The frequency component typically is less than 2mA/MHz, with \overline{OE} at V_{IH}.
- I_{CC} active while Embedded Algorithm (program or erase) is in progress.
- DC test conditions V_{IL} = 0.3V, V_{IH} = V_{CC} - 0.3V

CAPACITANCE

(T_A = +25°C)

Parameter	Symbol	Conditions	Max	Unit
\overline{OE} capacitance	C _{OE}	V _{IN} = 0 V, f = 1.0 MHz	50	pF
\overline{WE}_{1-4} capacitance HIP (PGA) HIP (Alternate pinout) CQFP G4T CQFP G2U G2 (Alternate pinout)	C _{WE}	V _{IN} = 0 V, f = 1.0 MHz	20 50 50 20 50	pF
\overline{CS}_{1-4} capacitance	C _{CS}	V _{IN} = 0 V, f = 1.0 MHz	20	pF
Data I/O capacitance	C _{I/O}	V _{I/O} = 0 V, f = 1.0 MHz	20	pF
Address input capacitance	C _{AD}	V _{IN} = 0 V, f = 1.0 MHz	50	pF

This parameter is guaranteed by design but not tested.



AC CHARACTERISTICS – WRITE/ERASE/PROGRAM OPERATIONS - \overline{WE} CONTROLLED

(V_{CC} = 5.0V, T_A = -55°C to +125°C)

Parameter	Symbol		-90		-120		-150		Unit
			Min	Max	Min	Max	Min	Max	
Write Cycle Time	t _{AVAV}	t _{WC}	90		120		150		ns
Chip Select Setup Time	t _{ELWL}	t _{CS}	0		0		0		ns
Write Enable Pulse Width	t _{WLWH}	t _{WP}	45		50		50		ns
Address Setup Time	t _{AVWL}	t _{AS}	0		0		0		ns
Data Setup Time	t _{DVWH}	t _{DS}	45		50		50		ns
Data Hold Time	t _{WHDX}	t _{DH}	0		0		0		ns
Address Hold Time	t _{WLAX}	t _{AH}	45		50		50		ns
Write Enable Pulse Width High	t _{WHWL}	t _{WPH}	20		20		20		ns
Duration of Byte Programming Operation (1)	t _{WHWH1}			300		300		300	μs
Sector Erase (2)	t _{WHWH2}			15		15		15	sec
Read Recovery Time before Write	t _{GHWL}		0		0		0		μs
V _{CC} Setup Time	t _{VCS}		50		50		50		μs
Chip Programming Time				44		44		44	sec
Chip Erase Time (3)				256		256		256	sec
Output Enable Hold Time (4)		t _{OEH}	10		10		10		ns
RESET Pulse Width (5)		t _{RP}	500		500		500		ns

NOTES:

1. Typical value for t_{WHWH1} is 7μs.
2. Typical value for t_{WHWH2} is 1sec.
3. Typical value for Chip Erase Time is 32sec.
4. For Toggle and Data Polling.
5. RESET internally tied to V_{CC} for the default pin configuration in the HIP package.

AC CHARACTERISTICS – READ-ONLY OPERATIONS

(V_{CC} = 5.0V, T_A = -55°C to +125°C)

Parameter	Symbol		-90		-120		-150		Unit
			Min	Max	Min	Max	Min	Max	
Read Cycle Time	t _{AVAV}	t _{RC}	90		120		150		ns
Address Access Time	t _{AVQV}	t _{ACC}		90		120		150	ns
Chip Select Access Time	t _{ELQV}	t _{CCE}		90		120		150	ns
Output Enable to Output Valid	t _{GLOV}	t _{OE}		40		50		55	ns
Chip Select High to Output High Z (1)	t _{EHQZ}	t _{DF}		20		30		35	ns
Output Enable High to Output High Z (1)	t _{GHQZ}	t _{DF}		20		30		35	ns
Output Hold from Addresses, \overline{CS} or \overline{OE} Change, whichever is First	t _{AXQX}	t _{OH}	0		0		0		ns
RST Low to Read Mode (1,2)		t _{Ready}		20		20		20	μs

1. Guaranteed by design, not tested.
2. RESET internally tied to V_{CC} for the default pin configuration in the HIP package.

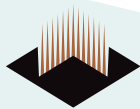

AC CHARACTERISTICS – WRITE/ERASE/PROGRAM OPERATIONS, \overline{CS} CONTROLLED

($V_{CC} = 5.0V, V_{SS} = 0V, T_A = -55^{\circ}C$ to $+125^{\circ}C$)

Parameter	Symbol		-90		-120		-150		Unit
			Min	Max	Min	Max	Min	Max	
Write Cycle Time	tAVAV	tWC	90		120		150		ns
Write Enable Setup Time	tWLEL	tWS	0		0		0		ns
Chip Select Pulse Width	tELEH	tCP	45		50		50		ns
Address Setup Time	tAVEL	tAS	0		0		0		ns
Data Setup Time	tDVEH	tDS	45		50		50		ns
Data Hold Time	tEHDX	tDH	0		0		0		ns
Address Hold Time	tELAX	tAH	45		50		50		ns
Chip Select Pulse Width High	tEHEL	tCPH	20		20		20		ns
Duration of Byte Programming Operation (1)	tWHWH1			300		300		300	μ s
Sector Erase Time (2)	tWHWH2			15		15		15	sec
Read Recovery Time	tGHEL		0		0		0		μ s
Chip Programming Time				44		44		44	sec
Chip Erase Time (3)				256		256		256	sec
Output Enable Hold Time (4)		tOEH	10		10		10		ns

NOTES:

1. Typical value for tWHWH1 is 7 μ s.
2. Typical value for tWHWH2 is 1sec.
3. Typical value for Chip Erase Time is 32sec.
4. For Toggle and Data Polling.

**FIG. 3
AC TEST CIRCUIT**

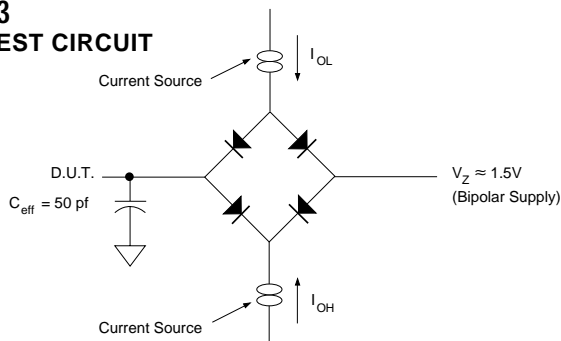

AC TEST CONDITIONS

Parameter	Typ	Unit
Input Pulse Levels	$V_{IL} = 0, V_{IH} = 3.0$	V
Input Rise and Fall	5	ns
Input and Output Reference Level	1.5	V
Output Timing Reference Level	1.5	V

NOTES:

V_z is programmable from -2V to +7V.
 I_{OL} & I_{OH} programmable from 0 to 16mA.
 Tester Impedance $Z_0 = 75 \Omega$.
 V_z is typically the midpoint of V_{OH} and V_{OL} .
 I_{OL} & I_{OH} are adjusted to simulate a typical resistive load circuit.
 ATE tester includes jig capacitance.

**FIG. 4
RESET TIMING DIAGRAM**

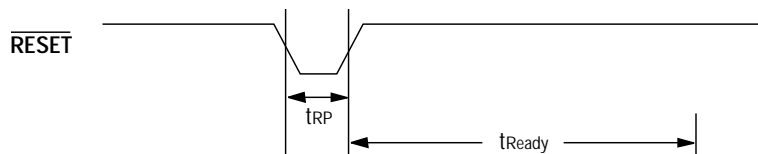



FIG. 5
AC WAVEFORMS FOR READ OPERATIONS

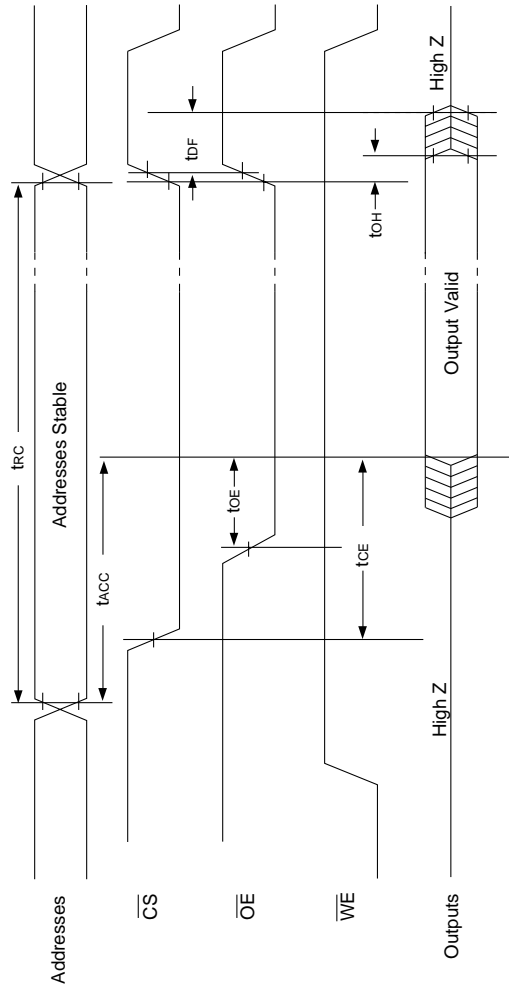
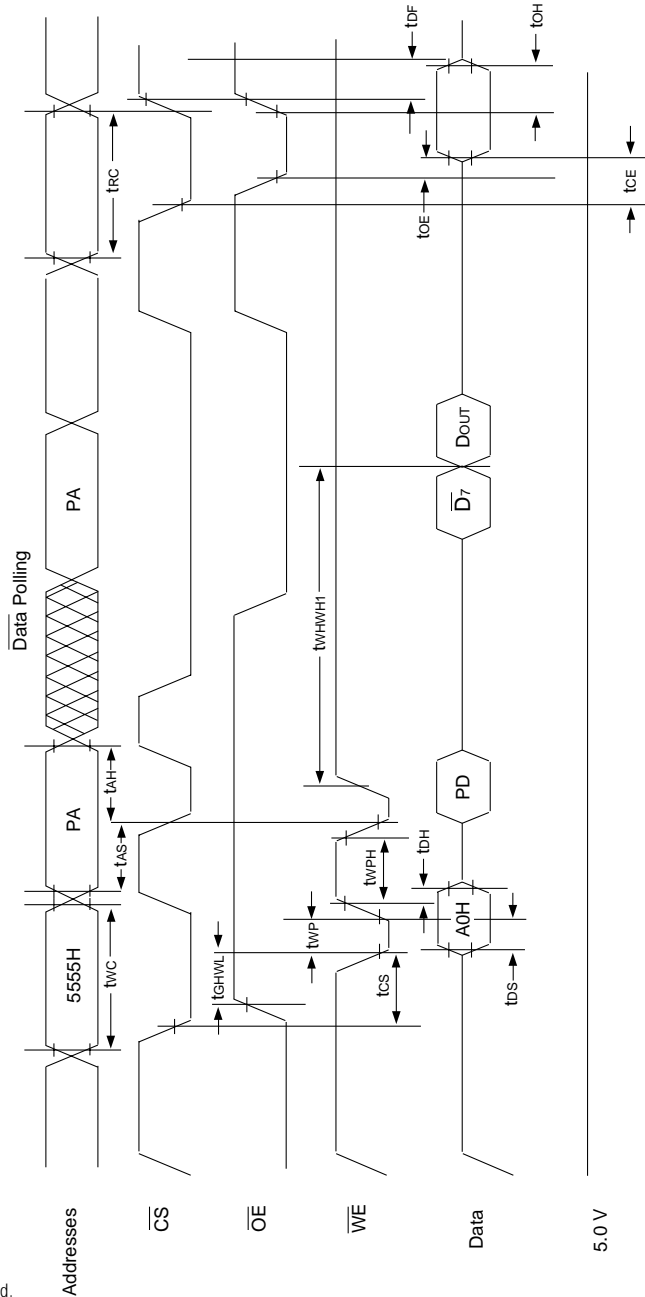



FIG. 6
WRITE/ERASE/PROGRAM
OPERATION, WE CONTROLLED



NOTES:

1. PA is the address of the memory location to be programmed.
2. PD is the data to be programmed at byte address.
3. D7 is the output of the complement of the data written to each chip.
4. DOUT is the output of the data written to the device.
5. Figure indicates last two bus cycles of four bus cycle sequence.



FIG. 7
AC WAVEFORMS CHIP/SECTOR
ERASE OPERATIONS

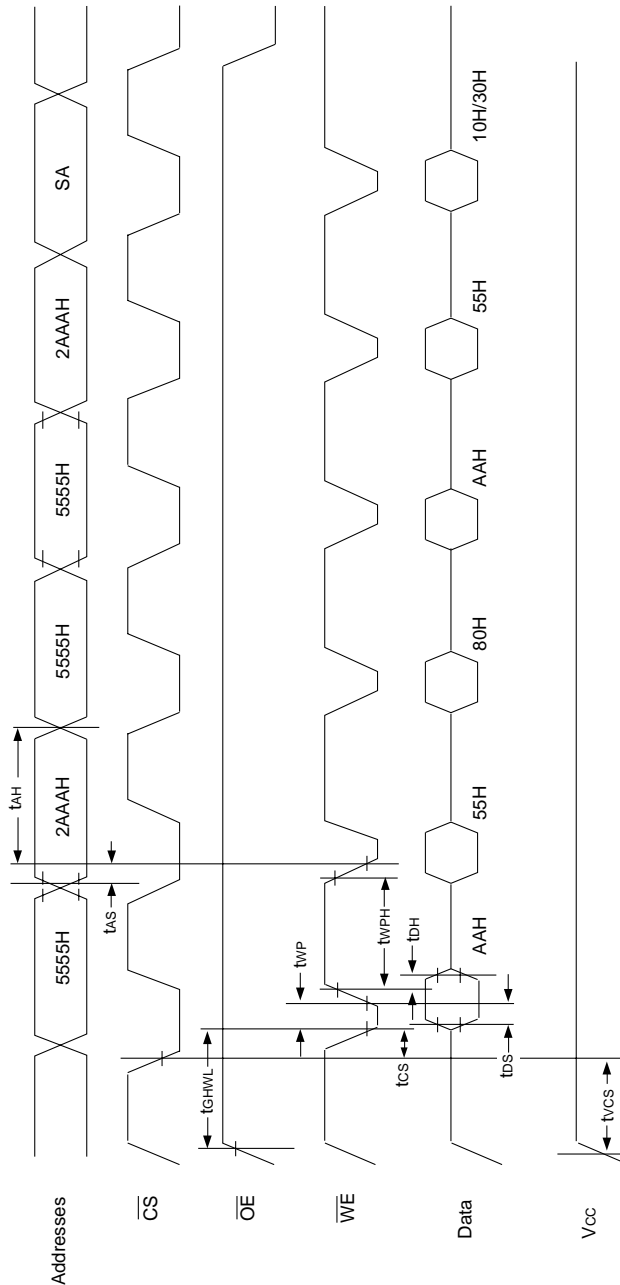

NOTE:
1. SA is the sector address for Sector Erase.



FIG. 8
AC WAVEFORMS FOR DATA POLLING
DURING EMBEDDED ALGORITHM OPERATIONS

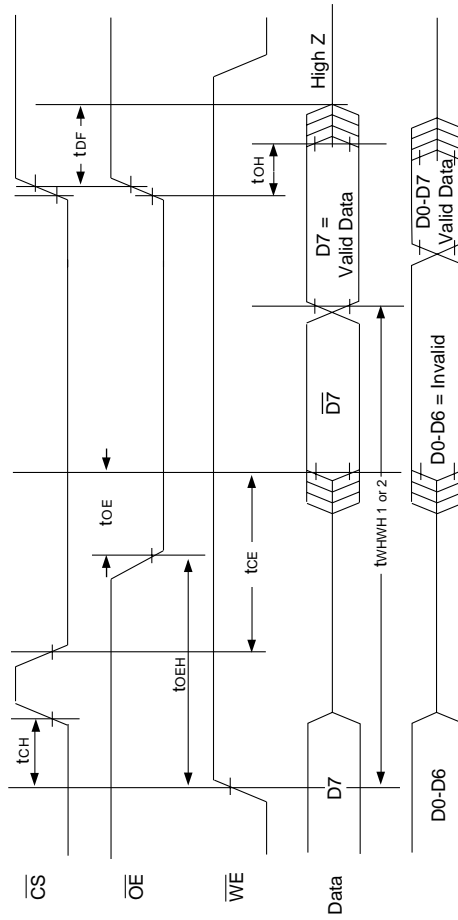
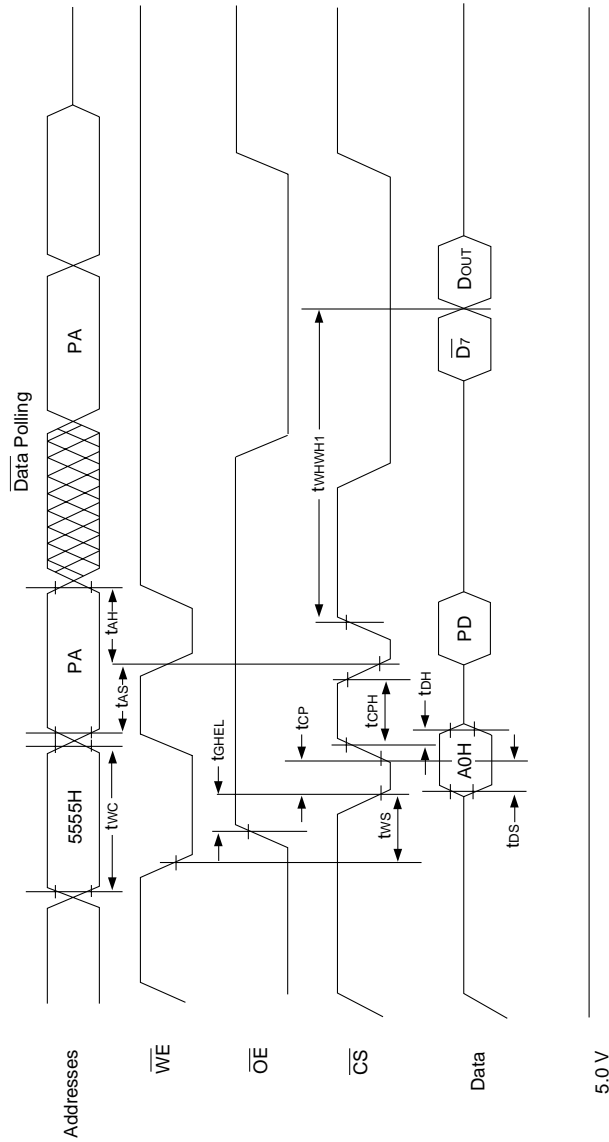



FIG. 9
ALTERNATE \overline{CS} CONTROLLED
PROGRAMMING OPERATION TIMINGS



NOTES:

1. PA represents the address of the memory location to be programmed.
2. PD represents the data to be programmed at byte address.
3. D7 is the output of the complement of the data written to each chip.
4. Dout is the output of the data written to the device.
5. Figure indicates the last two bus cycles of a four bus cycle sequence.



FIG. 10 ALTERNATE PIN CONFIGURATION FOR WF2M32I-XHX5

TOP VIEW

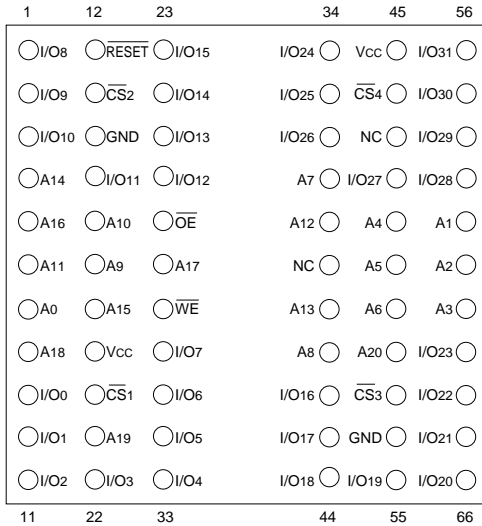

PIN DESCRIPTION

I/O0-31	Data Inputs/Outputs
A0-20	Address Inputs
WE	Write Enable
CS1-4	Chip Selects
OE	Output Enable
Vcc	Power Supply
GND	Ground
RESET	Reset

BLOCK DIAGRAM

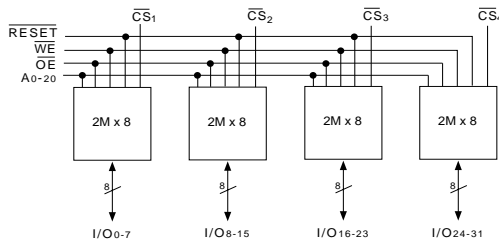
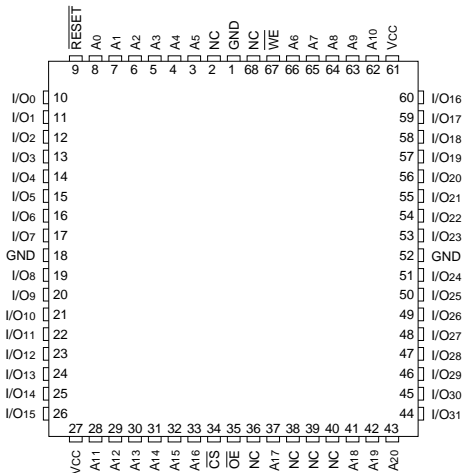

FIG. 11 ALTERNATE PIN CONFIGURATION FOR WF2M32U-XG2UX5

TOP VIEW



PIN DESCRIPTION

I/O0-31	Data Inputs/Outputs
A0-20	Address Inputs
WE	Write Enable
CS	Chip Select
OE	Output Enable
Vcc	Power Supply
GND	Ground
RESET	Reset

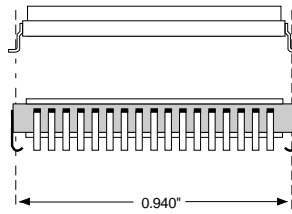

The White 68 lead G2U CQFP fills the same fit and function as the JEDEC 68 lead CQFJ or 68 PLCC. But the G2U has the TCE and lead inspection advantage of the CQFP form.

BLOCK DIAGRAM

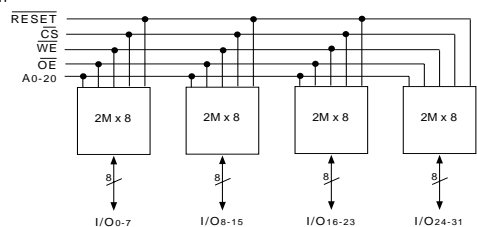



PACKAGE 401: 66 PIN, PGA TYPE, CERAMIC HEX-IN-LINE PACKAGE, HIP (H)

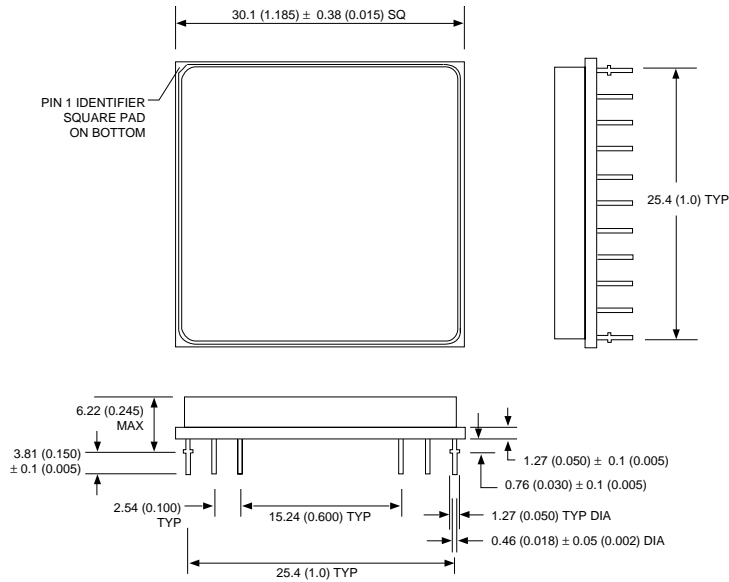

ALL LINEAR DIMENSIONS ARE MILLIMETERS AND PARENTHETICALLY IN INCHES



PACKAGE 510: 68 LEAD, CERAMIC QUAD FLAT PACK, CQFP (G2U)

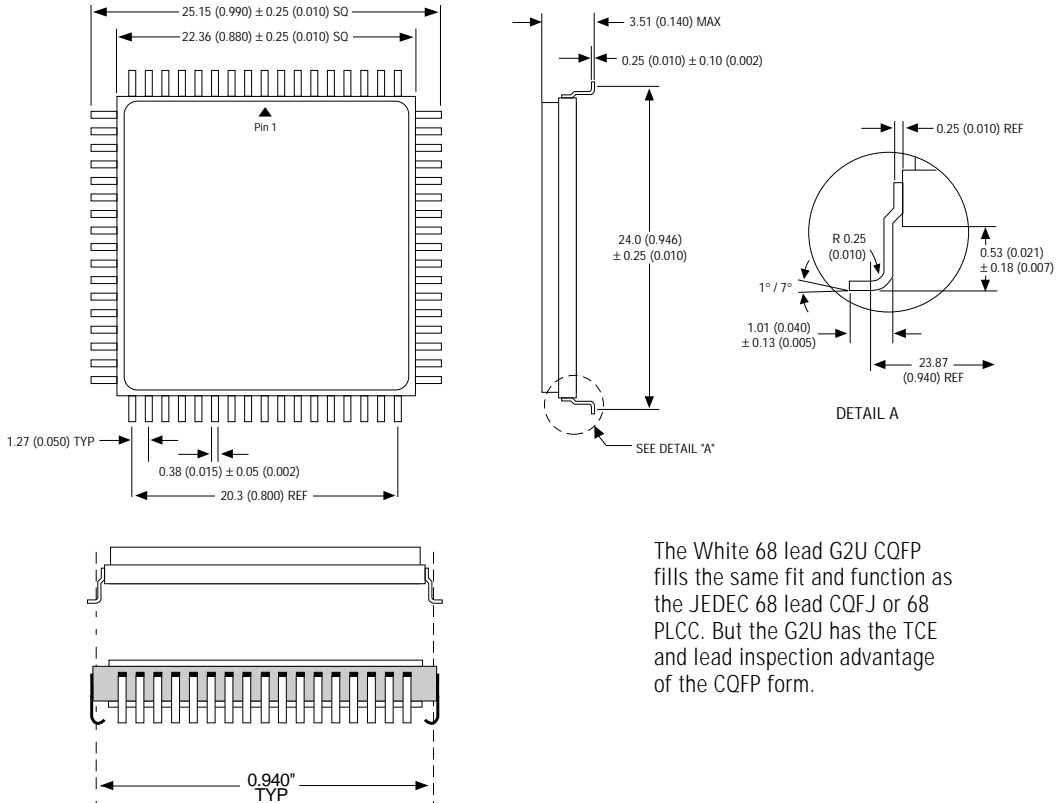

The White 68 lead G2U CQFP fills the same fit and function as the JEDEC 68 lead CQFJ or 68 PLCC. But the G2U has the TCE and lead inspection advantage of the CQFP form.

ALL LINEAR DIMENSIONS ARE MILLIMETERS AND PARENTHETICALLY IN INCHES



ORDERING INFORMATION



DEVICE TYPE	SECTOR SIZE	SPEED	PACKAGE	SMD NO.
2M x 32 5V Flash Module	64KByte	150ns	66 pin HIP (H)	5962-97531 01HXX*
2M x 32 5V Flash Module	64KByte	120ns	66 pin HIP (H)	5962-97531 02HXX*
2M x 32 5V Flash Module	64KByte	90ns	66 pin HIP (H)	5962-97531 03HXX*
2M x 32 5V Flash Module	64KByte	150ns	68 lead CQFP/J (G2U)	5962-97531 01HXX*
2M x 32 5V Flash Module	64KByte	120ns	68 lead CQFP/J (G2U)	5962-97531 02HXX*
2M x 32 5V Flash Module	64KByte	90ns	68 lead CQFP/J (G2U)	5962-97531 03HXX*

* Pending