



DBS-series



Feature

- Ideal for distributed power systems
- Thin and small size
- Built-in overcurrent, overvoltage and thermal protection circuits
- Built-in remote ON/OFF (on both side of input and output)
- Inverter operating monitoring (IOG)
- Mounting hole (M3 tapped)
- The beat noise is decreased by installing of the crystal oscillator (DBS700)

CE marking

- Low Voltage Directive
- RoHS Directive

Safety agency approvals

- UL, C-UL recognized, TÜV approved

5-year warranty

DBS100A/DBS150A

DB S 150 A 15

① ② ③ ④ ⑤

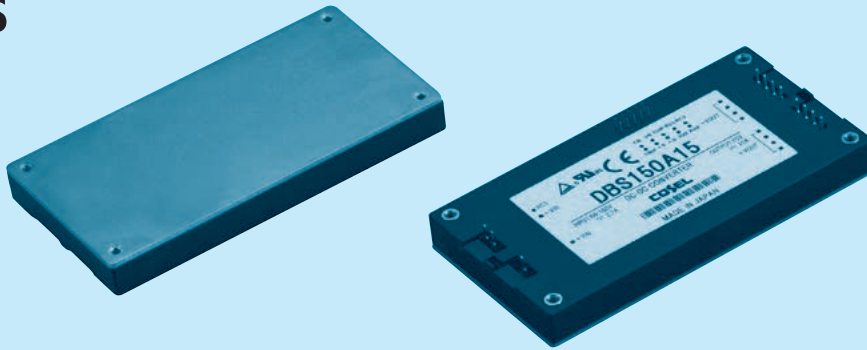

- ① Series name
- ② Single output
- ③ Output wattage
- ④ Input voltage
A :DC110V input
- ⑤ Output voltage

MODEL	DBS100A05	DBS100A13R8	DBS150A12	DBS150A15	DBS150A24
MAX OUTPUT WATTAGE[W]	100	100.7	150	150	151
DC OUTPUT	5V 20A	13.8V 7.3A	12V 12.5A	15V 10A	24V 6.3A

SPECIFICATIONS

	MODEL	DBS100A05	DBS100A13R8	DBS150A12	DBS150A15	DBS150A24	
INPUT	VOLTAGE[V]	DC45 - 160		DC66 - 160			
	CURRENT[A]	*1 1.11typ	1.10typ	1.57typ	1.59typ	1.58typ	
	EFFICIENCY[%]	*1 82typ	83typ	87typ	86typ	87typ	
OUTPUT	VOLTAGE[V]	5	13.8	12	15	24	
	CURRENT[A]	20	7.3	12.5	10	6.3	
	LINE REGULATION[mV]	20max	60max	40max	60max	95max	
	LOAD REGULATION[mV]	40max	150max	100max	150max	190max	
	RIPPLE[mVp-p]	0 to +85°C *2	80max	120max	120max	120max	120max
		-20 - 0°C *2	140max	160max	160max	160max	160max
	RIPPLE NOISE[mVp-p]	0 to +85°C *2	100max	150max	150max	150max	150max
		-20 - 0°C *2	150max	180max	180max	180max	180max
	TEMPERATURE REGULATION[mV]	0 to +65°C	50max	180max	120max	180max	280max
		-20 to +85°C	85max	310max	200max	310max	480max
DRIFT[mV]	*3 20max	60max	40max	60max	90max		
START-UP TIME[ms]	200max (DCIN 110V, Io=100%)						
OUTPUT VOLTAGE ADJUSTMENT RANGE	Fixed (TRM pin open), 60 - 110% adjustable by external VR or external voltage						
OUTPUT VOLTAGE SETTING[V]	4.90 - 5.20	13.25 - 14.35	11.60 - 12.60	14.40 - 15.60	23.04 - 24.96		
PROTECTION CIRCUIT AND OTHERS	OVERCURRENT PROTECTION	Works over 105% of rating and recovers automatically					
	OVERVOLTAGE PROTECTION	5.75 - 7.00V	15.87 - 19.32V	13.80 - 16.80V	17.25 - 21.00V	27.60 - 33.60V	
	REMOTE SENSING	Provided					
	REMOTE ON/OFF	Provided (On both side of input and output)					
ISOLATION	INPUT-OUTPUT	AC3,000V 1minute, Cutoff current = 10mA, DC500V 50MΩ min (20±15°C)					
	INPUT-FG	AC2,000V 1minute, Cutoff current = 10mA, DC500V 50MΩ min (20±15°C)					
	OUTPUT-FG	AC500V 1minute, Cutoff current = 100mA, DC500V 50MΩ min (20±15°C)					
	OUTPUT-RC2.RC3	AC100V 1minute, Cutoff current = 100mA, DC100V 10MΩ min (20±15°C)					
ENVIRONMENT	OPERATING TEMP.HUMID.AND ALTITUDE *4	-20 to +85°C (On aluminum base plate), 20 - 95%RH (Non condensing) (Refer to "Derating"), 3,000m (10,000feet) max					
	STORAGE TEMP.HUMID.AND ALTITUDE	-40 to +85°C, 20 - 95%RH (Non condensing), 9,000m (30,000feet) max					
	VIBRATION	10 - 55Hz, 49.0m/s ² (5G), 3minutes period, 60minutes each along X, Y and Z axis					
	IMPACT	196.1m/s ² (20G), 11ms once each along X, Y and Z axis					
SAFETY	AGENCY APPROVALS	UL60950-1, C-UL, EN62368-1					
OTHERS	CASE SIZE/WEIGHT	61 × 12.7 × 116.8mm [2.4 × 0.5 × 4.6 inches] (W×H×D) / 150g max					
	COOLING METHOD	Conduction cooling (e.g. heat radiation from the aluminum base plate to the attached heat sink)					

*1 At rated input(DC110V) and rated load.

*2 Ripple and ripple noise is measured by using measuring board with the recommended capacitor Co & the film capacitor 0.1 μF. Measured by 20MHz oscilloscope or Ripple-Noise meter (Equivalent to KEISOKU-GIKEN:RM101). Refer to the manual.

*3 Drift is the change in DC output for an eight hour period after a half-hour warm-up at 25°C, with the input voltage held constant at the rated input/output.

*4 Please consult us in regard to use from -40°C.

External view

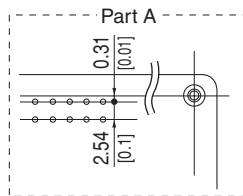
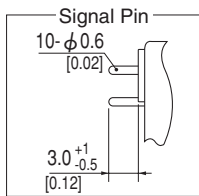
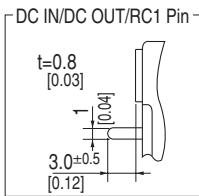
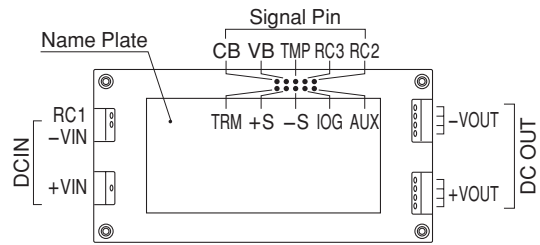
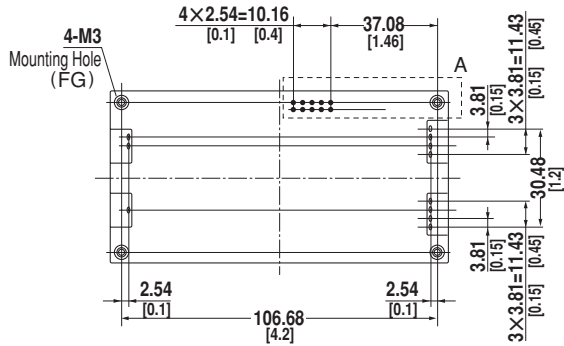
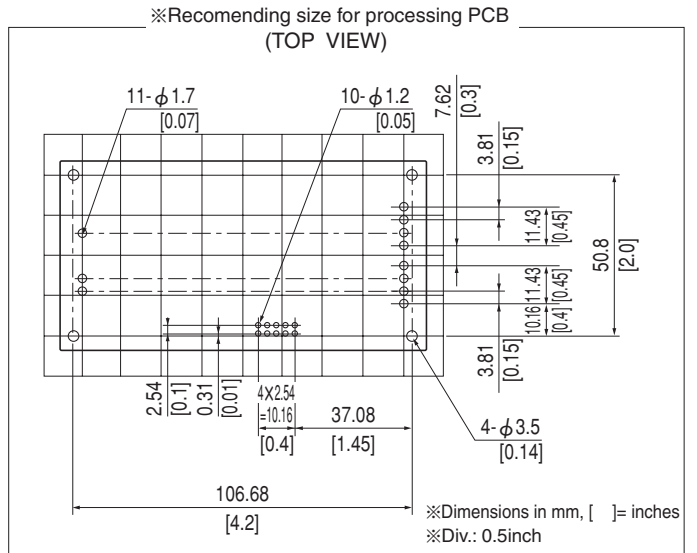
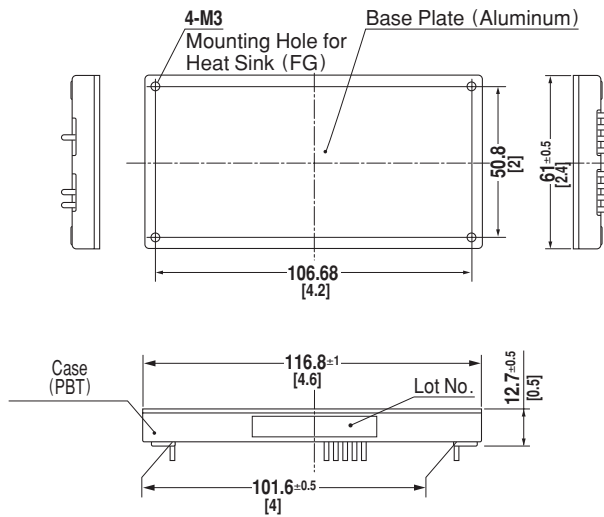

- ※Weight: 150g max
- ※Tolerance: ±0.3 [±0.012]
- ※Base Plate: Aluminum
- ※Dimensions in mm, [] = inches
- ※Mounting hole screwing torque: 0.49N·m(5.0kgf·cm)

DBS200B

DB S 200 B 03

① ② ③ ④ ⑤



RoHS

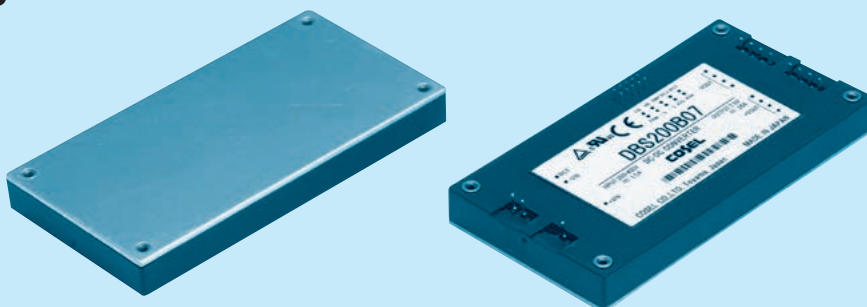

- ① Series name
- ② Single output
- ③ Output wattage
- ④ Input voltage
B : DC200 - 400V
- ⑤ Output voltage

MODEL	DBS200B03	DBS200B05	DBS200B07	DBS200B12
MAX OUTPUT WATTAGE[W]	165	200	210	240
DC OUTPUT	3.3V 50A	5V 40A	7.5V 28A	12V 20A

SPECIFICATIONS

	MODEL	DBS200B03	DBS200B05	DBS200B07	DBS200B12	
INPUT	VOLTAGE[V]	DC200 - 400				
	CURRENT[A]	*1 0.75typ	0.86typ	0.87typ	0.99typ	
	EFFICIENCY[%]	*1 79typ	83typ	86typ	87typ	
OUTPUT	VOLTAGE[V]	3.3	5	7.5	12	
	CURRENT[A]	50	40	28	20	
	LINE REGULATION[mV]	16max	20max	30max	40max	
	LOAD REGULATION[mV]	30max	40max	60max	100max	
	RIPPLE[mVp-p]	0 to +85°C *2	80max	80max	100max	120max
		-20 - 0°C *2	140max	140max	150max	160max
	RIPPLE NOISE[mVp-p]	0 to +85°C *2	100max	100max	140max	150max
		-20 - 0°C *2	150max	150max	160max	180max
	TEMPERATURE REGULATION[mV]	0 to +65°C	35max	50max	75max	120max
		-20 to +85°C	60max	85max	130max	200max
DRIFT[mV]	*3	16max	20max	30max	40max	
START-UP TIME[ms]	200max (DCIN 280V, Io=100%)					
OUTPUT VOLTAGE ADJUSTMENT RANGE	Fixed (TRM pin open), 60 - 110% adjustable by external VR or external voltage					
OUTPUT VOLTAGE SETTING[V]	3.25 - 3.45	4.90 - 5.20	7.25 - 7.85	11.60 - 12.60		
PROTECTION CIRCUIT AND OTHERS	OVERCURRENT PROTECTION	Works over 105% of rating and recovers automatically				
	OVERVOLTAGE PROTECTION	4.00 - 5.50V	5.75 - 7.00V	8.60 - 10.50V	13.80 - 16.80V	
	REMOTE SENSING	Provided				
	REMOTE ON/OFF	Provided (On both side of input and output)				
ISOLATION	INPUT-OUTPUT	AC3,000V 1minute, Cutoff current = 10mA, DC500V 50MΩ min (20±15°C)				
	INPUT-FG	AC2,000V 1minute, Cutoff current = 10mA, DC500V 50MΩ min (20±15°C)				
	OUTPUT-FG	AC500V 1minute, Cutoff current = 100mA, DC500V 50MΩ min (20±15°C)				
	OUTPUT-RC2.RC3	AC100V 1minute, Cutoff current = 100mA, DC100V 10MΩ min (20±15°C)				
ENVIRONMENT	OPERATING TEMP.HUMID.AND ALTITUDE *4	-20 to +85°C (On aluminum base plate), 20 - 95%RH (Non condensing) (Refer to "Derating"), 3,000m (10,000feet) max				
	STORAGE TEMP.HUMID.AND ALTITUDE	-40 to +85°C, 20 - 95%RH (Non condensing), 9,000m (30,000feet) max				
	VIBRATION	10 - 55Hz, 49.0m/s ² (5G), 3minutes period, 60minutes each along X, Y and Z axis				
	IMPACT	196.1m/s ² (20G), 11ms once each along X, Y and Z axis				
SAFETY	AGENCY APPROVALS	UL60950-1, C-UL, EN62368-1 Complies with DEN-AN and IEC60950-1				
OTHERS	CASE SIZE/WEIGHT	61 × 12.7 × 116.8mm [2.4 × 0.5 × 4.6 inches] (W×H×D) / 150g max				
	COOLING METHOD	Conduction cooling (e.g. heat radiation from the aluminum base plate to the attached heat sink)				

*1 At rated input(DC280V) and rated load.

*2 Ripple and ripple noise is measured by using measuring board with the recommended capacitor Co & the film capacitor 0.1 μF. Measured by 20MHz oscilloscope or Ripple-Noise meter (Equivalent to KEISOKU-GIKEN:RM101). Refer to the manual.

*3 Drift is the change in DC output for an eight hour period after a half-hour warm-up at 25°C, with the input voltage held constant at the rated input/output.

*4 Please consult us in regard to use from -40°C.

External view

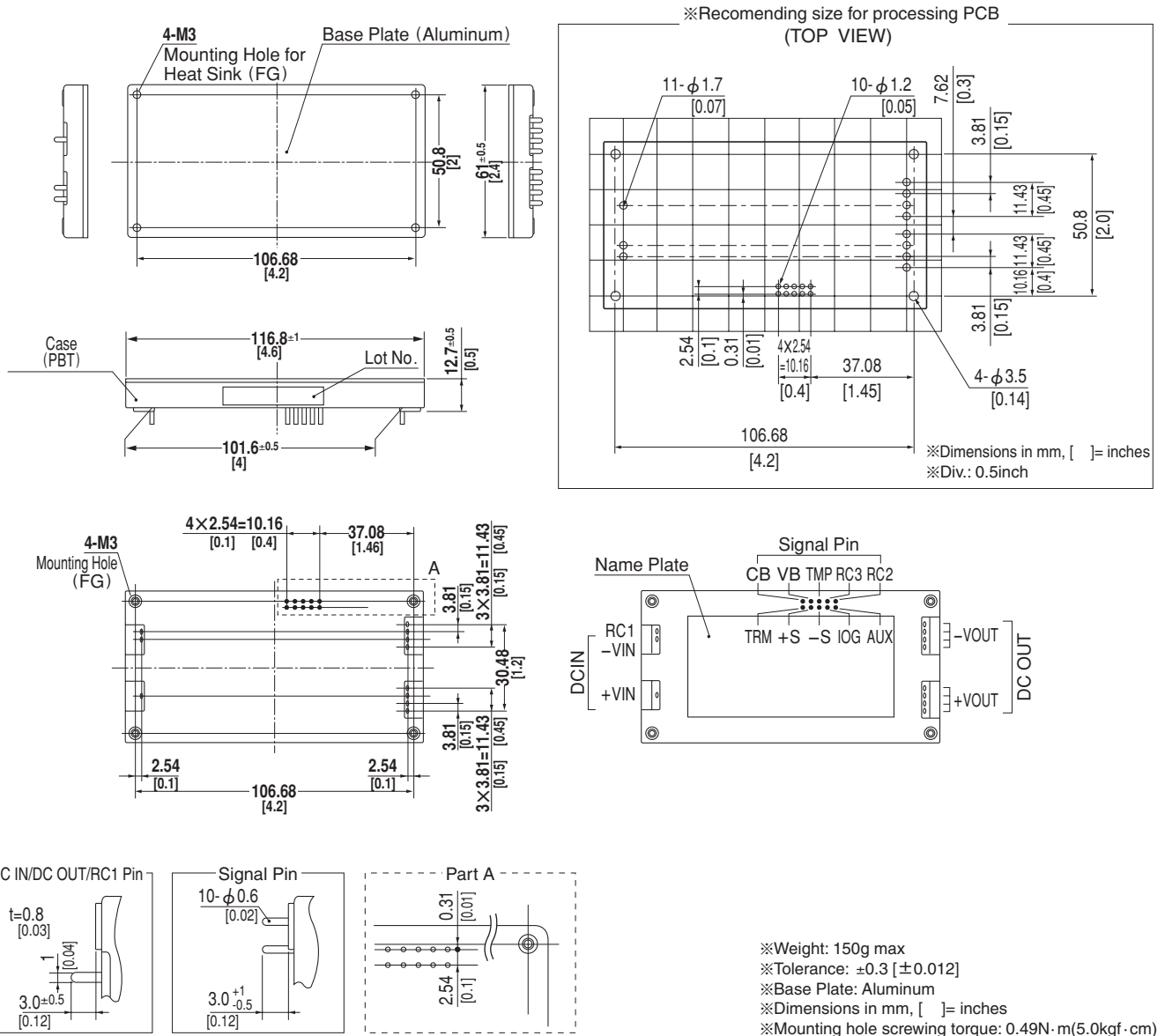

Performance data

INPUT CURRENT CHARACTERISTICS (DBS200B12)

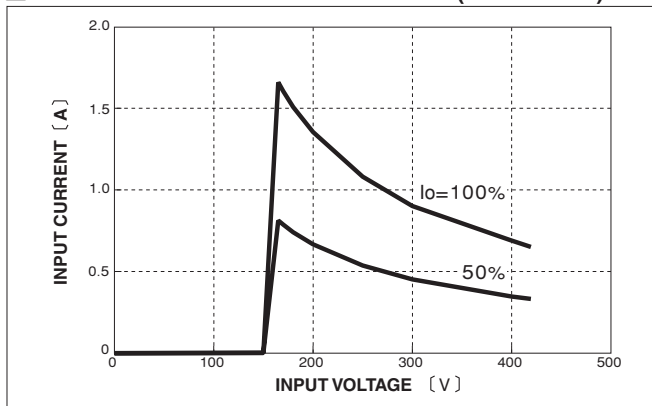

EFFICIENCY CHARACTERISTICS

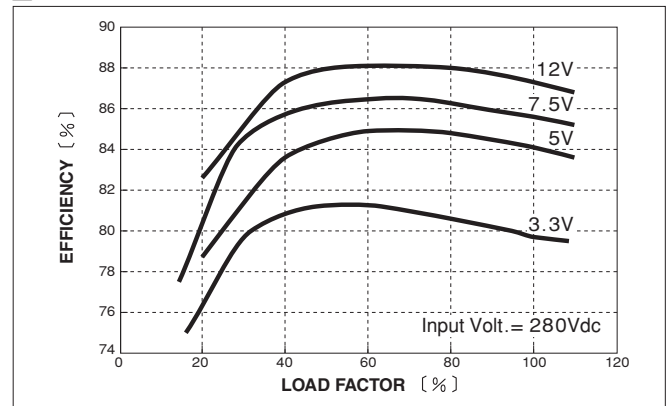

DBS400B

DB S 400 B 03

① ② ③ ④ ⑤



RoHS

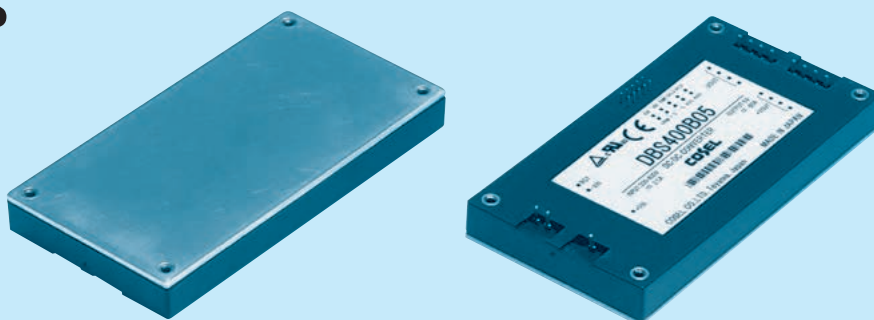

- ① Series name
- ② Single output
- ③ Output wattage
- ④ Input voltage
B : DC200 - 400V
- ⑤ Output voltage

MODEL	DBS400B03	DBS400B05	DBS400B07	DBS400B12	DBS400B15	DBS400B18	DBS400B24	DBS400B28
MAX OUTPUT WATTAGE[W]	264	400	405	408	405	396	408	406
DC OUTPUT	3.3V 80A	5V 80A	7.5V 54A	12V 34A	15V 27A	18V 22A	24V 17A	28V 14.5A

SPECIFICATIONS

	MODEL	DBS400B03	DBS400B05	DBS400B07	DBS400B12	DBS400B15	DBS400B18	DBS400B24	DBS400B28	
INPUT	VOLTAGE[V]	DC200 - 400								
	CURRENT[A]	*1 1.19typ	1.72typ	1.68typ	1.67typ	1.66typ	1.61typ	1.67typ	1.63typ	
	EFFICIENCY[%]	*1 79typ	83typ	86typ	87typ	87typ	89typ	87typ	88typ	
OUTPUT	VOLTAGE[V]	3.3	5	7.5	12	15	18	24	28	
	CURRENT[A]	80	80	54	34	27	22	17	14.5	
	LINE REGULATION[mV]	16max	20max	30max	40max	60max	60max	95max	95max	
	LOAD REGULATION[mV]	30max	40max	60max	100max	150max	150max	190max	190max	
	RIPPLE[mVp-p]	0 to +85°C *2	80max	80max	100max	120max	120max	120max	120max	120max
		-20 - 0°C *2	140max	140max	150max	160max	160max	160max	160max	160max
	RIPPLE NOISE[mVp-p]	0 to +85°C *2	100max	100max	140max	150max	150max	150max	150max	150max
		-20 - 0°C *2	150max	150max	160max	180max	180max	180max	180max	180max
	TEMPERATURE REGULATION[mV]	0 to +65°C	35max	50max	75max	120max	180max	180max	280max	280max
		-20 to +85°C	60max	85max	130max	200max	310max	310max	480max	480max
DRIFT[mV]	*3	16max	20max	30max	40max	60max	60max	90max	90max	
START-UP TIME[ms]	200max (DCIN 280V, Io=100%)									
OUTPUT VOLTAGE ADJUSTMENT RANGE	Fixed (TRM pin open), 60 - 110% adjustable by external VR or external voltage									
OUTPUT VOLTAGE SETTING[V]	3.25 - 3.45	4.90 - 5.20	7.25 - 7.85	11.60 - 12.60	14.40 - 15.60	17.28 - 18.72	23.04 - 24.96	26.88 - 29.12		
PROTECTION CIRCUIT AND OTHERS	OVERCURRENT PROTECTION	Works over 105% of rating and recovers automatically								
	OVERVOLTAGE PROTECTION	4.00 - 5.50V	5.75 - 7.00V	8.60 - 10.50V	13.80 - 16.80V	17.25 - 21.00V	20.70 - 25.20V	27.60 - 33.60V	32.20 - 39.20V	
	REMOTE SENSING	Provided								
	REMOTE ON/OFF	Provided (On both side of input and output)								
ISOLATION	INPUT-OUTPUT	AC3,000V 1minute, Cutoff current = 10mA, DC500V 50MΩ min (20±15°C)								
	INPUT-FG	AC2,000V 1minute, Cutoff current = 10mA, DC500V 50MΩ min (20±15°C)								
	OUTPUT-FG	AC500V 1minute, Cutoff current = 100mA, DC500V 50MΩ min (20±15°C)								
	OUTPUT-RC2.RC3	AC100V 1minute, Cutoff current = 100mA, DC100V 10MΩ min (20±15°C)								
ENVIRONMENT	OPERATING TEMP.HUMID.AND ALTITUDE *4	-20 to +85°C (On aluminum base plate), 20 - 95%RH (Non condensing) (Refer to "Derating"), 3,000m (10,000feet) max								
	STORAGE TEMP.HUMID.AND ALTITUDE	-40 to +85°C, 20 - 95%RH (Non condensing), 9,000m (30,000feet) max								
	VIBRATION	10 - 55Hz, 49.0m/s ² (5G), 3minutes period, 60minutes each along X, Y and Z axis								
	IMPACT	196.1m/s ² (20G), 11ms once each along X, Y and Z axis								
SAFETY	AGENCY APPROVALS	UL60950-1, C-UL, EN62368-1 Complies with DEN-AN and IEC60950-1								
OTHERS	CASE SIZE/WEIGHT	61 × 12.7 × 116.8mm [2.4 × 0.5 × 4.6 inches] (W×H×D) / 180g max								
	COOLING METHOD	Conduction cooling (e.g. heat radiation from the aluminum base plate to the attached heat sink)								

*1 At rated input(DC280V) and rated load.

*2 Ripple and ripple noise is measured by using measuring board with the recommended capacitor Co & the film capacitor 0.1 μF. Measured by 20MHz oscilloscope or Ripple-Noise meter (Equivalent to KEISOKU-GIKEN:RM101). Refer to the manual.

*3 Drift is the change in DC output for an eight hour period after a half-hour warm-up at 25°C, with the input voltage held constant at the rated input/output.

*4 Please consult us in regard to use from -40°C.

External view

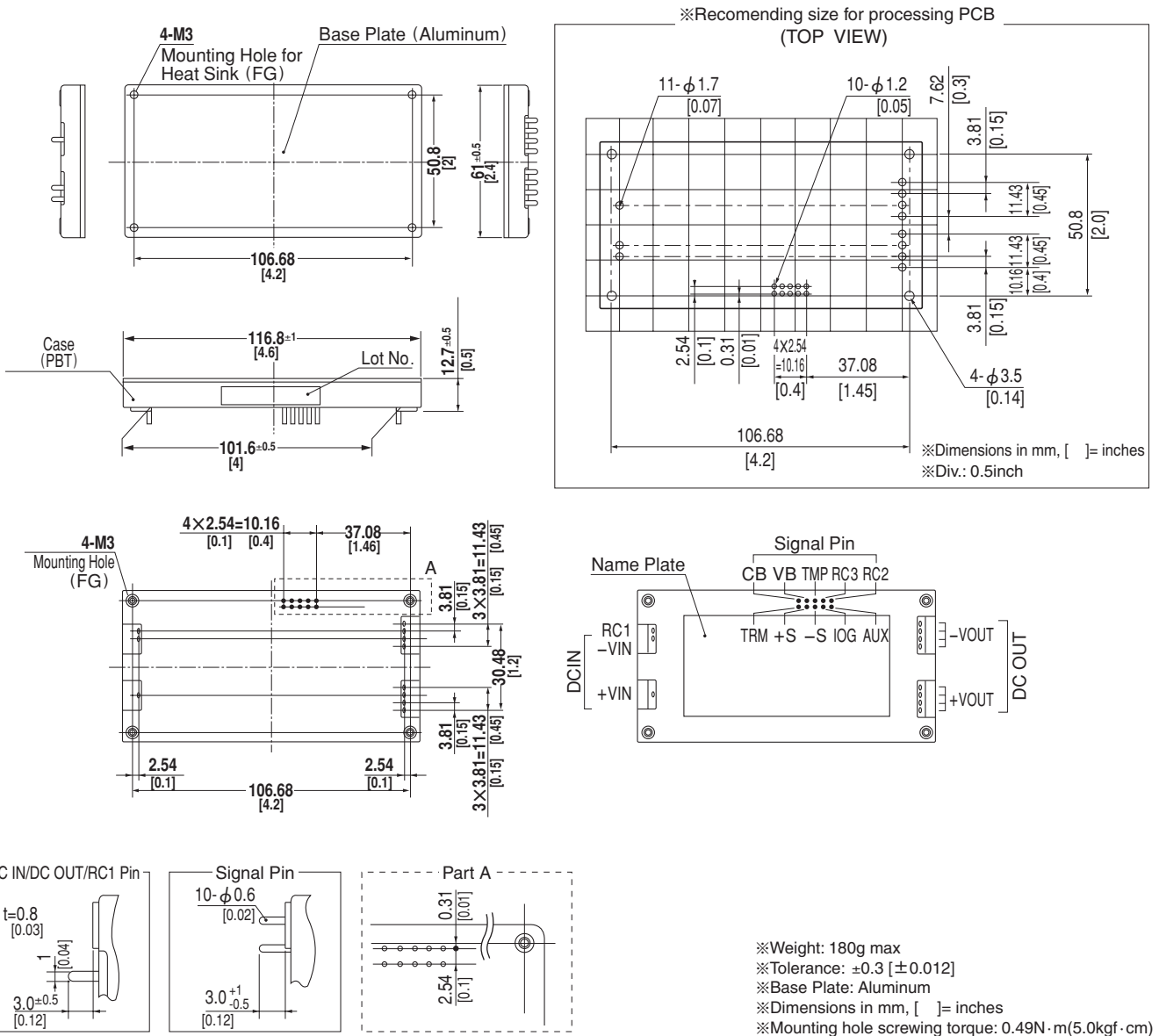

Performance data

INPUT CURRENT CHARACTERISTICS (DBS400B12)

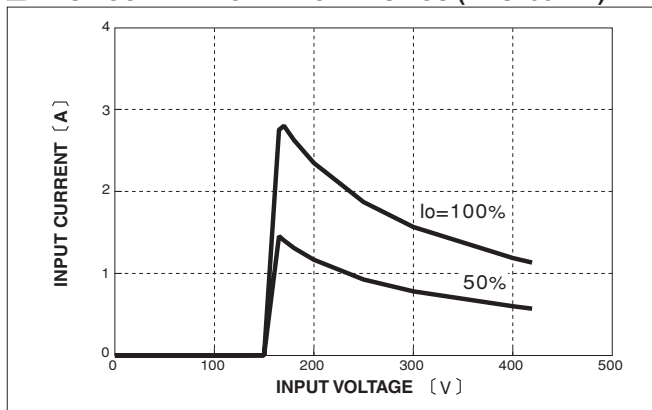

EFFICIENCY CHARACTERISTICS

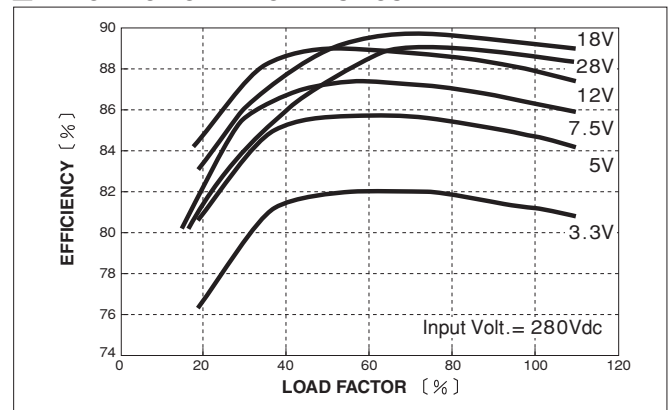

DBS700B

DB S 700 B 28 -□

① ② ③ ④ ⑤ ⑥

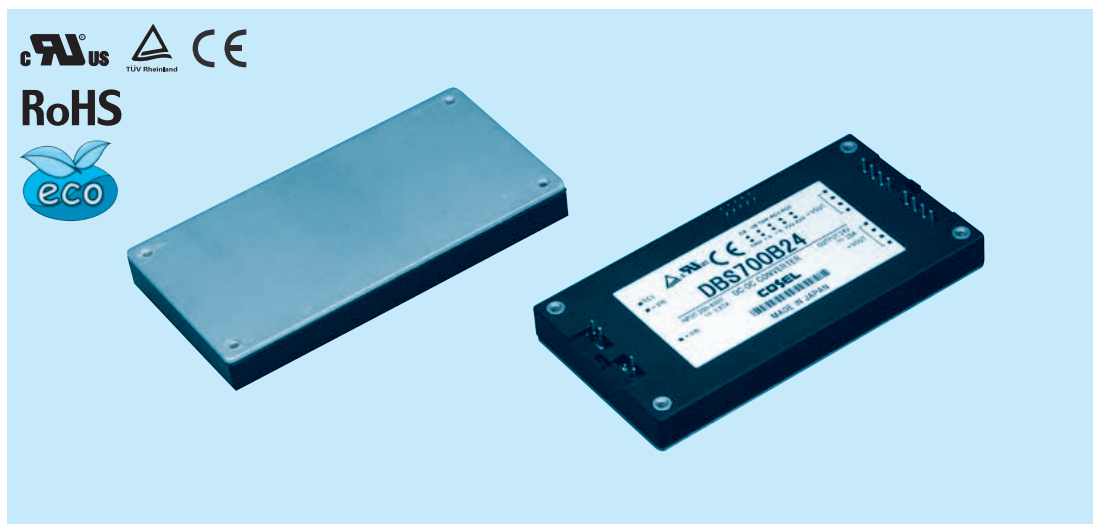

- ① Series name
- ② Single output
- ③ Output wattage
- ④ Input voltage
B : DC200 - 400V
- ⑤ Output voltage
- ⑥ Optional
T : with Mounting hole
(φ 3.4 thru)

MODEL	DBS700B12	DBS700B24	DBS700B28	DBS700B36	DBS700B48
MAX OUTPUT WATTAGE[W]	696	696	700	702	696
DC OUTPUT	12V 58A	24V 29A	28V 25A	36V 19.5A	48V 14.5A

SPECIFICATIONS

	MODEL	DBS700B12	DBS700B24	DBS700B28	DBS700B36	DBS700B48	
INPUT	VOLTAGE[V]	DC200 - 400					
	CURRENT[A]	*1 2.76typ	2.76typ	2.76typ	2.76typ	2.73typ	
	EFFICIENCY[%]	*1 90.0typ	90.0typ	90.5typ	90.0typ	91.0typ	
OUTPUT	VOLTAGE[V]	12	24	28	36	48	
	CURRENT[A]	58	29	25	19.5	14.5	
	LINE REGULATION[mV]	40max	95max	95max	95max	120max	
	LOAD REGULATION[mV]	100max	190max	190max	200max	240max	
	RIPPLE[mVp-p]	0 to +100°C*2	120max	120max	120max	150max	200max
		-40 to 0°C*2	160max	160max	160max	200max	250max
	RIPPLE NOISE[mVp-p]	0 to +100°C*2	150max	150max	150max	200max	250max
		-40 to 0°C*2	180max	180max	180max	240max	400max
	TEMPERATURE REGULATION[mV]	0 to +65°C	120max	280max	280max	360max	480max
		-40 to +100°C	200max	480max	480max	680max	960max
DRIFT[mV]	*3 40max	90max	90max	120max	180max		
START-UP TIME[ms]	200max (DCIN 280V, Io=100%)						
OUTPUT VOLTAGE ADJUSTMENT RANGE *4	Fixed (TRM pin open), 60 - 110% adjustable by external VR or external voltage						
OUTPUT VOLTAGE SETTING[V]	11.64 - 12.36	23.28 - 24.72	27.16 - 28.84	34.92 - 37.08	46.56 - 49.44		
PROTECTION CIRCUIT AND OTHERS	OVERCURRENT PROTECTION	Works over 105% of rating and recovers automatically					
	OVERVOLTAGE PROTECTION	14.40 - 16.80V	27.60 - 33.60V	32.20 - 39.20V	41.40 - 50.40V	55.20 - 63.00V	
	REMOTE SENSING	Provided					
	REMOTE ON/OFF	Provided (On both side of input and output)					
ISOLATION	INPUT-OUTPUT	AC3,000V 1minute, Cutoff current = 10mA, DC500V 50MΩ min (20±15°C)					
	INPUT-FG	AC2,000V 1minute, Cutoff current = 10mA, DC500V 50MΩ min (20±15°C)					
	OUTPUT-FG	AC500V 1minute, Cutoff current = 100mA, DC500V 50MΩ min (20±15°C)					
	OUTPUT-RC2,RC3	AC100V 1minute, Cutoff current = 100mA, DC100V 10MΩ min (20±15°C)					
ENVIRONMENT	OPERATING TEMP.,HUMID.AND ALTITUDE	-40 to +100°C (On aluminum base plate), 20 - 95%RH (Non condensing) (Refer to "Derating"), 3,000m (10,000feet) max					
	STORAGE TEMP.,HUMID.AND ALTITUDE	-40 to +100°C, 20 - 95%RH (Non condensing), 9,000m (30,000feet) max					
	VIBRATION	10 - 55Hz, 49.0m/s ² , 3minutes period, 60minutes each along X, Y and Z axis					
	IMPACT	196.1m/s ² , 11ms once each along X, Y and Z axis					
SAFETY	AGENCY APPROVALS	UL60950-1, C-UL, EN62368-1					
OTHERS	CASE SIZE/WEIGHT	61 × 12.7 × 116.8mm [2.4 × 0.5 × 4.6 inches] (W×H×D) / 180g max					
	COOLING METHOD	Conduction cooling (e.g. heat radiation from the aluminum base plate to the attached heat sink)					

*1 At rated input(DC280V) and rated load.

*2 Ripple and ripple noise is measured by using measuring board with the recommended capacitor Co & the film capacitor 0.1 μF. Refer to the manual.

*3 Drift is the change in DC output for an eight hour period after a half-hour warm-up at 25°C, with the input voltage held constant at the rated input/output.

*4 Refer to the manual for the input range.

External view

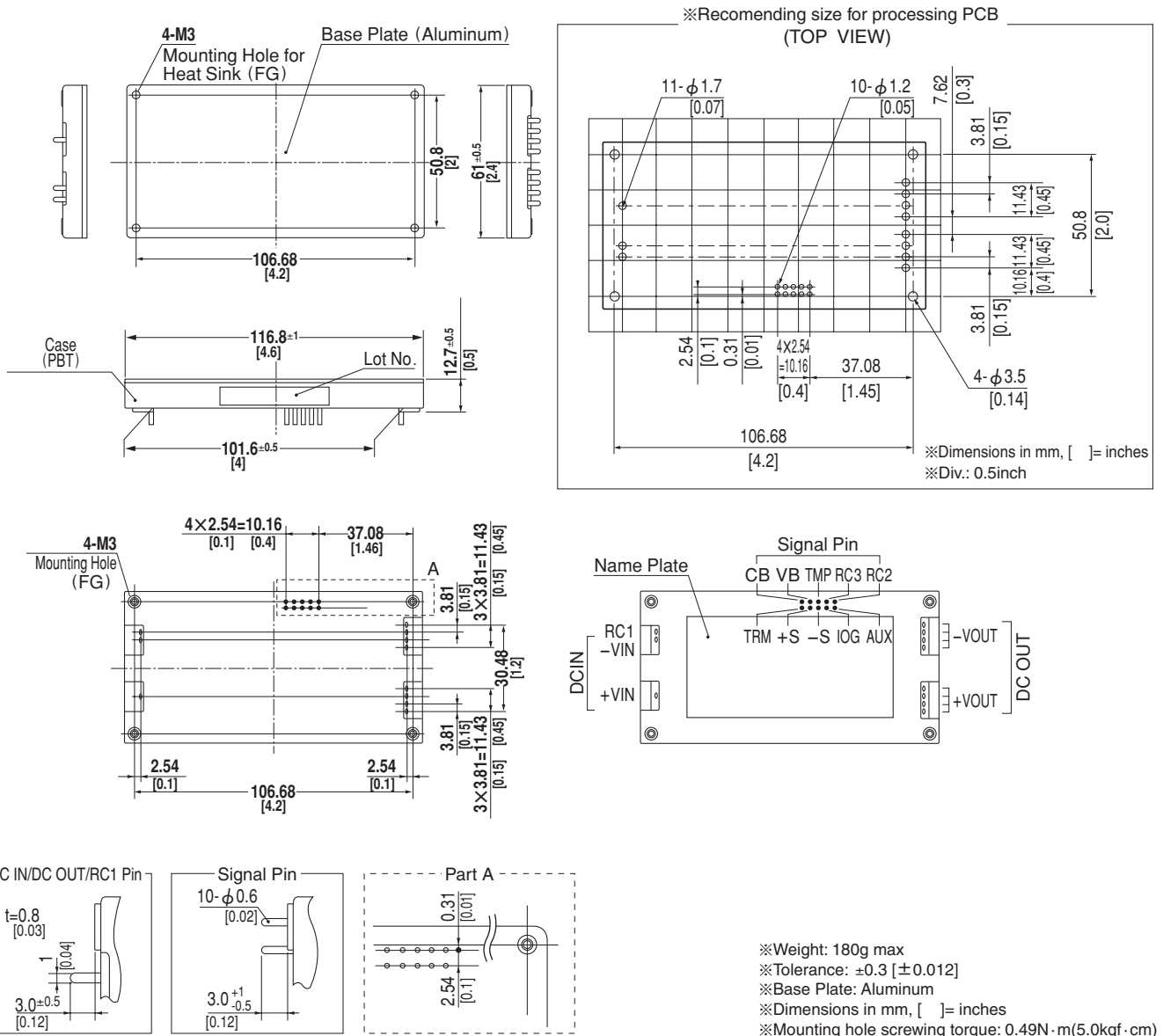

Performance data

INPUT CURRENT CHARACTERISTICS (DBS700B28)

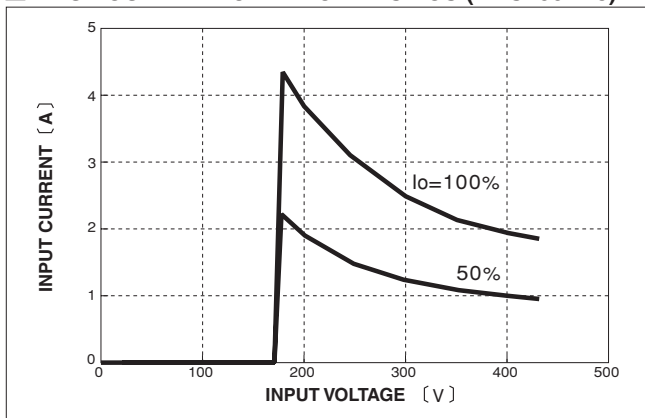

EFFICIENCY CHARACTERISTICS (DBS700B28)

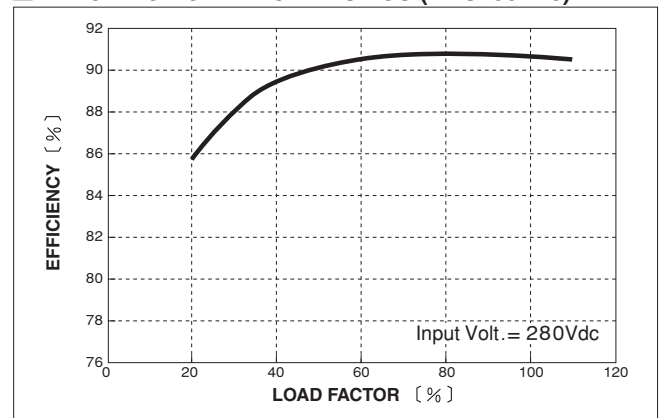

Pin Configuration

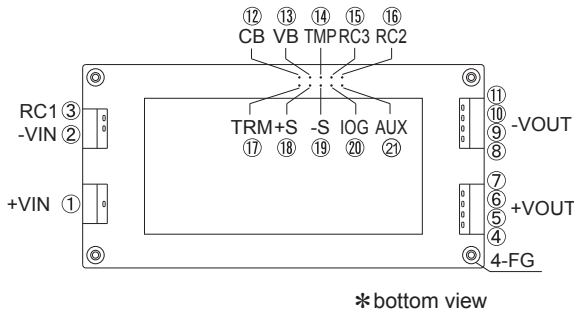

NO.	Pin Connection	Function
①	+VIN	+DC input
②	-VIN	-DC input
③	RC1	Remote ON/OFF(Input side)
④ ⑤ ⑥ ⑦	+VOUT	+DC output
⑧ ⑨ ⑩ ⑪	-VOUT	-DC output
⑫	CB	Current balance
⑬	VB	Voltage balance
⑭	TMP	Thermal detection signal
⑮	RC3	Remote ON/OFF(output side)
⑯	RC2	
⑰	TRM	Adjustment of output voltage
⑱	+S	+Remote sensing
⑲	-S	-Remote sensing
⑳	IOG	Inverter operation monitor
㉑	AUX	Auxiliary power supply
—	FG	Mounting hole(FG)

Implementation • Mounting Method

Mounting method

- The unit can be mounted in any direction. When two or more power supplies are used side by side, position them with proper intervals to allow enough air ventilation. Aluminum base plate temperature around each power supply should not exceed the temperature range shown in "Derating".
- Avoid placing the DC input line pattern lay out underneath the unit, it will increase the line conducted noise. Make sure to leave an ample distance between the line pattern lay out and the unit. Also avoid placing the DC output line pattern underneath the unit because it may increase the output noise. Lay out the pattern away from the unit.
- High-frequency noise radiates directly from the unit to the atmosphere. Therefore, design the shield pattern on the printed circuit board and connect its one to FG. The shield pattern prevents noise radiation.

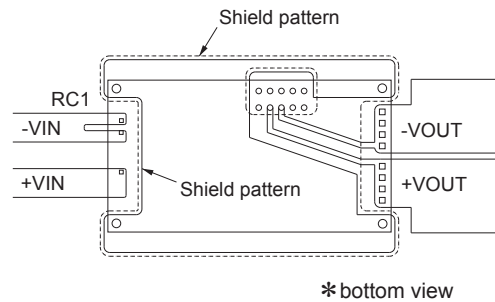

Stress onto the pins

- When too much stress is applied to the pins of the power supply, the internal connection may be weakened. As shown in right figure avoid applying stress of more than 29.4N (3kgf) on the input pins/output pins (A part) and more than 9.8N (1kgf) to the signal pins (B part).
- The pins are soldered on PCB internally, therefore, do not pull or bend them with abnormal forces.
- Mounting hole diameter of PCB should be 3.5mm to reduce the stress onto the pins.
- Fix the unit on PCB(fixing fittings) by screws to reduce the stress onto the pins. Be sure to mount the unit first, then solder the unit.

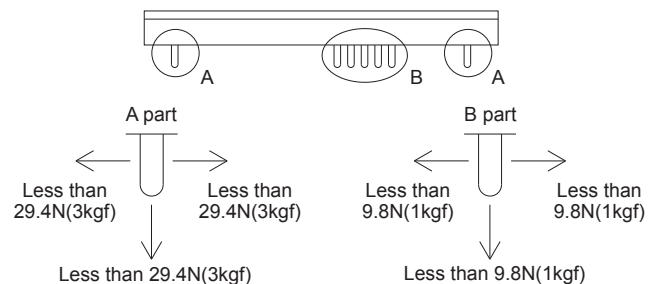

Soldering temperature

- Flow soldering : 260°C less than 15 seconds.
- Soldering iron
 - DC IN/DC OUT/RC1 : 450°C less than 5 seconds.
 - Signal pins : 350°C less than 3 seconds (less than 20W)

Derating

- Use with the conduction cooling (e.g. heat radiation by conduction from the aluminum base plate to the attached heat sink). Below shows the derating curve based on the aluminum base plate temperature. In the hatched area, the specification of ripple and ripple noise is different from other areas.
- It is necessary to note thermal fatigue life by power cycle. Please reduce the temperature fluctuation range as much as possible when the up and down of temperature are frequently generated. Contact for more information on cooling methods.

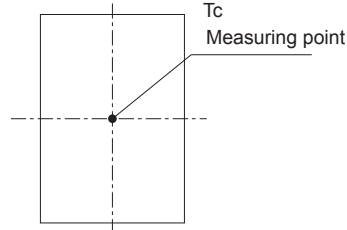
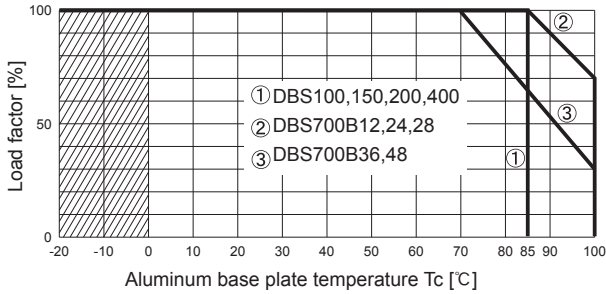

Instruction Manual

- ◆ It is necessary to read the “Instruction Manual” and “Before using our product” before you use our product.

Instruction Manual <https://en.cosel.co.jp/product/powersupply/DBS/>
 Before using our product <https://en.cosel.co.jp/technical/caution/index.html>

DBS



NOTICE



Basic Characteristics Data

Model	Circuit method	Switching frequency [kHz]	Input current [A]	Rated input fuse	Inrush current protection	PCB/Pattern			Series/Parallel operation availability	
						Material	Single sided	Double sided	Series operation	Parallel operation
DBS100A	Forward converter	370	1.10 *1	-	-	Aluminum	Yes		Yes	Yes
DBS150A	Forward converter	370	1.59 *1	-	-	Aluminum	Yes		Yes	Yes
DBS200B	Forward converter	370	0.99 *1	-	-	Aluminum	Yes		Yes	Yes
DBS400B	Forward converter	370	1.72 *1	-	-	Aluminum	Yes		Yes	Yes
DBS700B	Forward converter	381	2.76 *1	-	-	Aluminum	Yes		Yes	Yes

*1 The value of input current is at rated input and rated load.